



Catalogue

Table des matières

Table des matières	2
Attaches & Fixations	3
Adaptateur d'angle	3
Adaptateur surélevé	3
Serre	4
Attaches de Nylon & Sangles	5
Attache de Nylon - Tie Wrap	5
Sangle Velcro	5
Collier de serrage (Aussi dans Attaches & Fixations, QUINCAILLERIE ET DIVERS)	5
Barre de mise à la terre	6
Barre de mise à la terre en cuivre	6
Galvanized Bus Bars	8
Barre de mise à la terre Hydro Québec	8
QUINCAILLERIE DE BARRE DE MALT (Aussi dans QUINCAILLERIE ET DIVERS)	10
Connecteurs à Compression	11
Copper Lugs Terminals	11
Entrée de lignes	12
Entry Boots	12
Cushion Plugs	14
Entry Boots Cushions Inserts	14
Fenêtre d'entrée de lignes	16
Entry Blank Cover	16
Mise à la Terre & Étanchéité	17
Universal Grounding Kit	17
Clip-on Grounding Kit	17
Universal Weatherproofing Kit	17
Panier de Levage	18
Lace-up Hoisting grip	18
Pre-Laced hoisting grip	18
Paratonnerres & Accessoires	19
Lightning Rods - Air Terminal	19
Support de Tige Parafoudre	19
Cable holder	20
Protections de Rebords	21
Passe-fils	21
Protecteurs	21
Supports à câbles	22
Butterfly Hangers	22
Cable Blocks	22
Cushion Hangers (Aussi dans Entrée de lignes)	24
Hanger Inserts	24
Supports à Serrage	25
Support à Tuyau sur Tuyau	25
Support à Tuyaux à 90deg.	27
Support à Tuyau sur Fer-Angle	27
Support à Tuyau sur Mur ou Poteau de Bois	29

Adaptateur d'angle

Fastens hangers to tower angle members without drilling.

- Available with 3/8" tapped mounting holes or 3/4" holes for snap-in hangers
- 304 Stainless steel
- Hardware included
- Others models available upon request



Article #	Description	Quantité
-----------	-------------	----------

AAS38	Angle adapter with 3/8-16 tapped holes	10
--------------	--	----

Autres codes : **31768A**

AAU34	Snap-in angle adapter with 3/4" holes	10
--------------	---------------------------------------	----

Autres codes : **UA-3**

MAA38



MINI ANGLE ADAPTER FILETÉ 3/8-16

10

Autres codes : **243684**

Adaptateur surélevé

Provide an attachment point to 1" and larger round member for cable hanger.

Available with 3/8" tapped mounting holes or 3/4" holes for snap-ins.

- Stainless steel
- Accepts round member adapters and 1/2" banding
- Hardware included



Article #	Description	Quantité
-----------	-------------	----------

	Adaptateur surélevé (Stand-off) avec trous filetés 3/8"	
--	---	--

SOA-38	Utilisé avec collet a tuyau	10
---------------	-----------------------------	----

Autres codes : **SOAT, STANDOFF, LST**

	Snap-in adaptateur surélevé (stand-off) avec trous 3/4"	
--	---	--

SOA-SNP	utilisé avec collet a tuyau	10
----------------	-----------------------------	----

Autres codes : **SOASH, STANDOFF, LST-O**

Used with a variety of cable hangers or combined with entry boot cushion insert to create cushion hangers. Provide a smaller attachment point to round member for cable hangers.

- Stainless steel
- Accepts round member adapters and 1/2" banding



Article #	Description	Quantité
CLH	Mini tête de montage pour support à câble avec trou 3/8"	10

Attache de Nylon - Tie Wrap

- High strength and low thread force
- Consistent performance and reliability
- Infinite adjustability
- Stainless steel barb lock type
- For indoor and outdoor use
- UL listed
- Others sizes available upon request



Article #	Description	Quantité
TC48-186	Attache câble en nylon, 4.8mm x 186mm Autres codes : TY-25MX TY25MX TYRAP TY-RAP	1000
TC70-378	Attache câble en nylon, 7mm x 378mm Autres codes : TY-27MX TY27MX TYRAP TY-RAP	500

Sangle Velcro

S'enroule autour de n'importe quoi et se bloque à elle-même pour le groupage rapide et facile.

- Réutilisable
- Le moyen le plus rapide et le plus simple de regrouper les câbles, les fils et les cordons
- Résistant à l'eau et à l'humidité
- Pour usage intérieur et extérieur



Article #	Description	Quantité
SG1275B	Courroie auto-agrippante 1/2" x 75ft Black Autres codes : VELCRO	1
SG3475B	Courroie auto-agrippantes 3/4" x 75ft Black Autres codes : VELCRO	1

Collier de serrage (Aussi dans Attaches & Fixations, QUINCAILLERIE ET DIVERS)

- Collier de serrage entièrement en acier inoxydable.
- Verrou à vis avec tête hexagonale et fente pour tournevis.
- Autres tailles disponibles sur demande



Article #	Description	Quantité
HAS-72	Collier de serrage 3" to 5" Autres codes : HS72 HAS72 HS-72 ACHCK3050 COLLET	10
HAS-24	Collier de serrage 1" to 2" Autres codes : HS24 HAS24 HS-24 ACHCK1020 COLLET	10
HAS-40	Collier de serrage 2" to 3" Autres codes : HS40 HAS40 HS-40 ACHCK2030 COLLET	10
HAS-64	Collier de serrage 3-1/2" to 4-1/2" Autres codes : HS64 HAS64 HS-64 COLLET	10

Barre de mise à la terre en cuivre

Available in **Tinned copper** and **hot-dipped galvanized steel**.

- Add: **KU, KS, KT, or KR** to Bus Bar Part # to combine with **attachment kit**
- Custom sizes and models available upon request
- Also offer in **Bare copper** and **stainless steel**

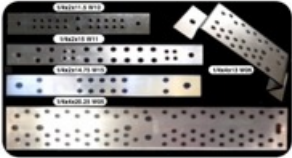

Article #	Description	Quantité
BB2075	Barre de mise à la terre en cuivre étamé, 7½" x 2" x ¼" pour boulons 3/8 x 1" cc	1
BB2120	Barre de mise à la terre en cuivre étamé, 12" x 2" x ¼" pour boulons 3/8 x 1" cc	1
BB2160	Barre de mise à la terre en cuivre étamé, 16" x 2" x ¼" pour boulons 3/8 x 1" cc Autres codes : TELUS	1
BB2240	Barre de mise à la terre en cuivre étamé, 24" x 2" x ¼" pour boulons 3/8 x 1" cc	1
BBM2075	Barre de mise à la terre en cuivre étamé, 7½" x 2" x ¼" pour boulons ¼ x 5/8" c/c Autres codes : BELL	1
BBU2060	Barre de mise à la terre en cuivre étamé, 6" x 2" x ¼" pour boulons 3/8 Universelle	1
BBU2100	Barre de mise à la terre en cuivre étamé, 10" x 2" x ¼" pour boulons 3/8 Universelle	1
BBU2120	Barre de mise à la terre en cuivre étamé, 12" x 2" x ¼" pour boulons 3/8 Universelle	1

Article #	Description	Quantité
BBU2140		
	Barre de mise à la terre en cuivre étamé, 14" x 2" x ¼" pour boulons 3/8 Universelle	1
	Autres codes : ROGERS, W04	
BB25125		
	Barre de mise à la terre en cuivre étamé, 12.5" x 2.5" x ¼" pour boulons 3/8	1
	Autres codes : VIDÉOTRON, ROGERS, UGBKIT-2T	
BB25195		
	Barre de mise à la terre en cuivre étamé, 19.5" x 2.5" x ¼" pour boulons 3/8	1
	Autres codes : UGBKIT-T	
BB25125-KU		
	Barre de mise à la terre en cuivre étamé (BB25125), 12.5" x 2.5" x ¼" pour boulons 3/8, avec ensemble de quincaillerie pour installation universel (BBAHKU).	1
	Autres codes : UGBKIT-2T	

Galvanized Bus Bars

Available in **Tinned copper** and **hot-dipped galvanized steel**.

- Add: **KU, KS, KT, or KR** to Bus Bar Part # to combine with **attachment kit**
- Custom sizes and models available upon request
- Also offer in **Bare copper** and **stainless steel**



Article #	Description	Quantité
-----------	-------------	----------

BB2185G

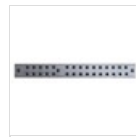

Barre de mise à la terre en acier galvanisé 18.5" x 2" x 1/4" pour boulons 3/8 x 1" cc

1

BB2240G



Barre de mise à la terre en acier galvanisé 24" x 2" x 1/4" pour boulons 3/8 x 1" cc

1

BB2120G

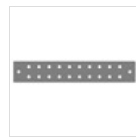

Barre de mise à la terre en acier galvanisé 12" x 2" x 1/4" pour boulons 3/8 x 1" cc

1

BBUGC



Barre de mise à la terre Universelle en acier galvanisé pour poteau clôture et tour

10" x 2" x 3/8"

1

Autres codes : **BELL UGC-001**

Barre de mise à la terre Hydro Québec

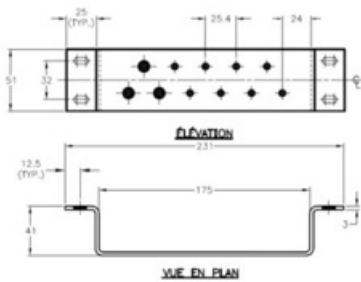

Article #	Description	Quantité
-----------	-------------	----------

TYPE 1-A

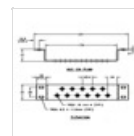

Barre copper 3mm, 231 x 51 x 41

1

TYPE 2-A

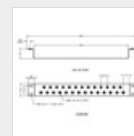

Barre copper 3mm, 435 x 51 x 41

1

PANI REDUITE

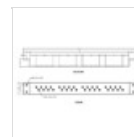

Cuivre nu 6mm, 835mm x 75mm, surélevé 51mm

Barre de mise à la terre principale (PANI) réduite

1

Autres codes : **N900-90900-124-01**

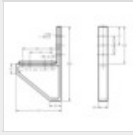
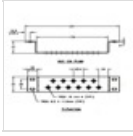
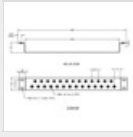
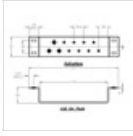
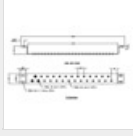
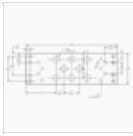
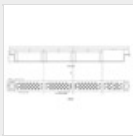
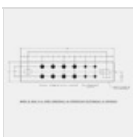
Article #	Description	Quantité
SUPPMALT2		
	Support en acier pour montage d'une barre de M.A.L.T. format réduit 8 trous (MALTREDUIT8TROUS)	2
	Autres codes : 5108-90121-006-02	
TYPE 1-B		
	Tinned copper 3mm, 231 x 51 x 41	1
TYPE 2-B		
	Tinned copper 3mm, 435 x 51 x 41	1
TYPE 1		
	Bare copper 3mm, 231 x 51 x 41	1
TYPE 2		
	Bare copper 3mm, 435 x 51 x 41	1
MALTREDUIT8TROUS	Cuivre nu 6.25mm, 300mm x 102mm	
	Barre de M.A.L.T. format réduit 8 trous, pour câble teck catégorie 5e	1
	Autres codes : 5108-90121-006-02	
PANI STANDARD	Cuivre nu 6mm, 1322mm x 102mm, surélevé 76mm	
	Barre de mise à la terre principale (PANI) standard	1
	Autres codes : N900-90900-122-01	
MALTHORRETEL	Cuivre nu 6mm, 242mm x 51mm	
	Barre de mise à la terre horizontale du répartiteur téléphonique	1
	Autres codes : N900-90900-152-02	

QUINCAILLERIE DE BARRE DE MALT (Aussi dans QUINCAILLERIE ET DIVERS)

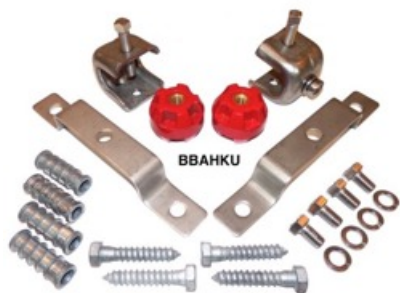

Article #	Description	Quantité
ISO138		
	Isolateur Rouge 1-3/8"H x 1-3/4"OD 3/8-16UNC	1
HANGBLT2		
	Hanger Bolt 3/8-16 x 2" plaqué zinc Autres codes : HANGBLTZ2	1
BBAHKU		
	Ensemble de quincaillerie pour installation d'une barre de MALT (mise à la terre). Ensemble universel.	1
BBAHKR		
	Ensemble de quincaillerie pour installer une barre de MALT (mise à la terre) sur un tuyau rond.	1
BBAHKS		
	Ensemble de quincaillerie pour installation d'une barre de MALT (mise à la terre) sur le mur d'un abris.	1
BBAHKT		
	Ensemble de quincaillerie pour installation d'une barre de MALT (mise à la terre) sur une patte de tour.	1

Copper Lugs Terminals

Lugs are tin-plated with number and color code printed, designed with cable inspection window.

- Standard number and color coded
- Others sizes available upon request



Article #	Description	Quantité
L61458	 <p>Cosse à 2 trous 1/4" avec 5/8" c/c, pour fil #6 Bleu</p> <p>Autres codes : 54205</p>	1
L6381U	 <p>Cosse à 2 trous 3/8" universel, pour fil #6</p> <p>Autres codes : 245529</p>	1
L21458	 <p>Cosse à 2 trous 1/4" avec 5/8" c/c, pour fil #2 Brun</p>	1
L21458C	 <p>Cosse à 2 trous 1/4" avec 5/8" c/c, pour fil #2 Brun</p> <p>Coudé à 90°</p>	1
L2381	 <p>Cosse à 2 trous 3/8" avec 1" c/c, pour fil #2 Brun</p>	1
L2381U	 <p>Cosse à 2 trous 3/8" universel, pour fil #2 Brun</p>	1
L20381	 <p>Cosse à 2 trous 3/8" avec 1" c/c, pour fil 2/0 Noir</p> <p>Autres codes : 54210, YA26L-2TC38</p>	1
L20381U	 <p>Cosse à 2 trous 3/8" universel, pour fil 2/0 Noir</p> <p>Autres codes : 54210, YA26L-2TC38</p>	1

Entry Boots

Provide an excellent seal against moisture while providing a support point for cable entering in a cabinet, building or shelter. 4" and 5"

- Weather and UV resistant EPDM rubber
- Custom sizes available upon request
- **Available in 4" for all models BT4-**-***



Article #	Description	Quantité
BT5-12-1	Boots 5" 1 trou pour câble coaxial 1/2"	1
BT5-12-3	Boots 5" 3 trous pour câble coaxial 1/2"	1
BT5-12-4	Boots 5" 4 trous pour câble coaxial 1/2"	1
BT5-12-6	Boots 5" 6 trous pour câble coaxial 1/2"	1
BT5-12-9	Boots 5" 9 trous pour câble coaxial 1/2"	1
BT5-58-1	Boots 5" 1 trou pour câble coaxial 5/8"	1
BT5-58-3	Boots 5" 3 trous pour câble coaxial 5/8"	1
BT5-58-4	Boots 5" 4 trous pour câble coaxial 5/8"	1
BT5-58-6	Boots 5" 6 trous pour câble coaxial 5/8"	1
BT5-78-1	Boots 5" 1 trou pour câble coaxial 7/8"	1
BT5-78-2	Boots 5" 2 trous pour câble coaxial 7/8"	1
BT5-78-3	Boots 5" 3 trous pour câble coaxial 7/8"	1
BT5-78-4	Boots 5" 4 trous pour câble coaxial 7/8"	1
BT5-114-1	Boots 5" 1 trou pour câble coaxial 1-1/4"	1
BT5-158-1	Boots 5" 1 trou pour câble coaxial 1-5/8"	1
FB5-78-6	 Flat Boots 5" 6 trous pour câble coaxial 7/8"	1
FB5-114-2	 Flat Boots 5" avec 2 trous pour câble coaxial 1-1/4"	1

Article #	Description	Quantité
BT4-12-1	Boots 4" 1 trou pour câble coaxial 1/2"	1
BT4-12-3	Boots 4" 3 trous pour câble coaxial 1/2"	1
BT4-12-4	Boots 4" 4 trous pour câble coaxial 1/2"	1
BT4-12-6	Boots 4" 6 trous pour câble coaxial 1/2"	1
BT4-12-9	Boots 4" 9 trous pour câble coaxial 1/2"	1
BT4-58-1	"Boots" 4" 1 trou pour câble coaxial 5/8"	1
BT4-58-3	Boots 4" 3 trous pour câble coaxial 5/8"	1
BT4-58-4	Boots 4" 4 trous pour câble coaxial 5/8"	1
BT4-58-6	(Boots) 4" 6 trous pour câble coaxial 5/8"	1
BT4-78-1	(Boots) 4" 1 trou pour câble coaxial 7/8"	1
BT4-78-2	(Boots) 4" 2 trous pour câble coaxial 7/8"	1
BT4-78-3	(Boots) 4" 3 trous pour câble coaxial 7/8"	1
BT4-78-4	(Boots) 4" 4 trous pour câble coaxial 7/8"	1
BT4-114-1	(Boots) 4" 1 trou pour câble coaxial 1-1/4"	1
BT4-158-1	(Boots) 4" 1 trou pour câble coaxial 1-5/8"	1
BT4-38-3	Boots 4" 3 trous pour câble coaxial 3/8"	1
BT4-38-4	Boots 4" 4 trous pour câble coaxial 3/8"	1
BT5-38-3	Boots 5" 3 trous pour câble coaxial 3/8"	1
BT5-38-4	Boots 5" 4 trous pour câble coaxial 3/8"	1

Cushion Plugs

For seal unused holes in entry boot cushions.

- Weather and UV resistant EPDM rubber
- Custom sizes available upon request



Article #	Description	Quantité
PLG-78	Bouchon pour trou 7/8 dans les coeurs de boots	10
PLG-12	Bouchon pour trou 1/2 dans les coeurs de boots	10

Entry Boots Cushions Inserts

Combined with boot to create boot assembly or with round member adapters to create cushion hangers.

- Weather and UV resistant EPDM rubber
- Custom sizes available upon request



Article #	Description	Quantité
CI-12-1	Coeur de boots avec 1 trou pour câble coaxial 1/2"	1
CI-12-3	Coeur de boots avec 3 trous pour câble coaxial 1/2"	1
CI-12-4	Coeur de boots avec 4 trous pour câble coaxial 1/2"	1
CI-12-9	Coeur de boots avec 9 trous pour câble coaxial 1/2"	1
CI-58-3	Coeur de boots avec 3 trous pour câble coaxial 5/8"	1
CI-58-4	Coeur de boots avec 4 trous pour câble coaxial 5/8"	1
CI-58-6	Coeur de boots avec 6 trous pour câble coaxial 5/8"	1
CI-78-1	Coeur de boots avec 1 trou pour câble coaxial 7/8"	1
CI-78-3	Coeur de boots avec 3 trous pour câble coaxial 7/8"	1
CI-78-4	Coeur de boots avec 4 trous pour câble coaxial 7/8"	1
CI-114-1	Coeur de boots avec 1 trou pour câble coaxial 1-1/4"	1
CI-BLANK	Coeur de boots sans trou	1
CI-58-1	Coeur de (boots) avec 1 trou pour câble coaxial 5/8"	1
CI-12-6	Coeur de (boots) avec 6 trous pour câble coaxial 1/2"	1
CI-38-3	Coeur de boots avec 3 trous pour câble coaxial 3/8"	1

Fenêtre d'entrée de lignes

Provide an excellent seal against moisture while providing a support point for cable entering in a cabinet, building or shelter. 4" and 5"

- Entry cap and hardware included
- Heavy duty aluminum construction
- Gray powder coated finish
- **Available in 4" for all models EP4****

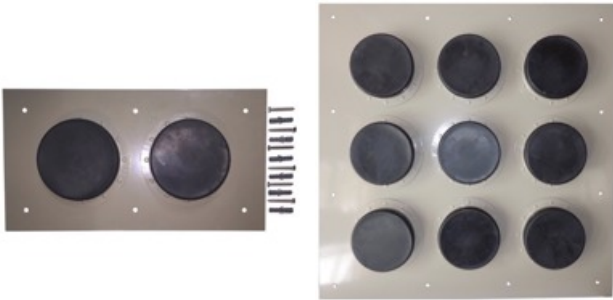

Article #	Description	Quantité
EP411	Fenêtre d'entrée de ligne 4" 1 trou, 1 x 1	1
EP412	Fenêtre d'entrée de ligne 4" 2 trous, 1 x 2	1
EP413	Fenêtre d'entrée de ligne 4" 3 trous, 1 x 3	1
EP422	Fenêtre d'entrée de ligne 4" 4 trous, 2 x 2	1
EP423	Fenêtre d'entrée de ligne 4" 6 trous, 2 x 3	1
EP433	Fenêtre d'entrée de ligne 4" 9 trous, 3 x 3	1
EP511	Fenêtre d'entrée de ligne 5" 1 trou, 1 x 1	1
EP512	Fenêtre d'entrée de ligne 5" 2 trous, 1 x 2	1
EP513	Fenêtre d'entrée de ligne 5" 3 trous, 1 x 3	1
EP522	Fenêtre d'entrée de ligne 5" 4 trous, 2 x 2	1
EP523	Fenêtre d'entrée de ligne 5" 6 trous, 2 x 3	1
EP533	Fenêtre d'entrée de ligne 5" 9 trous, 3 x 3	1

Entry Blank Cover

Blank cap for unused port on entry panel

- Weather and UV resistant EPDM rubber



Article #	Description	Quantité
BC4	Capuchon de fenêtre d'entrée de ligne 4"	1
BC5	Capuchon de fenêtre d'entrée de ligne 5"	1

Universal Grounding Kit



Article #	Description	Quantité
GK-UN5	Ensemble de mise à la terre universel pour câble 1/2" à 2-1/4" Autres codes : UG12158-15B4	1
GK-SNUV	Ensemble de mise à la terre universel pour câble coaxial 1/4" à 5/8" et Cat5e Autres codes : GK-SUNV	1

Clip-on Grounding Kit

Designed to be quickly clipped onto the cable and locked into place with a stainless steel grip.

- Reduces installation time
- Large contact area
- 5ft, 6AWG Copper Ground Lead
- Others sizes available upon request



Article #	Description	Quantité
GK-CLP-12	Ensemble de mise à la terre pour câble coaxial 1/2" modèle clip-on	1
GK-CLP-78	Ensemble de mise à la terre pour câble coaxial 7/8" modèle clip-on	1
GK-CLP-114	Ensemble de mise à la terre pour câble coaxial 1-1/4" modèle clip-on	1
GK-CLP-158	Ensemble de mise à la terre pour câble coaxial 1-5/8" modèle clip-on	1

Universal Weatherproofing Kit

- 6 Butyl rolls + 2 rolls narrow + 1 roll wide tape

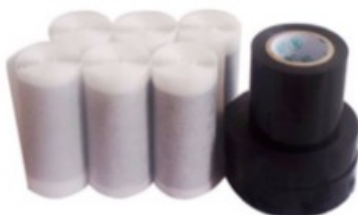

Article #	Description	Quantité
WP-KIT-U	Kit universel d'étanchéité pour connecteur. Autres codes : WPF8-1 SIUWP SI-UWP	1

Lace-up Hoisting grip

Lace-up hoisting grips provide an effective means of hoisting coax and elliptical waveguide and can be utilised to provide additional support once in place. The lace-up design allows the hoisting grip to be attached even when the run has been connectorized and facilitates easy positioning.

- Others sizes available upon request
- Lace-up at any point on coax
- Open mesh with single eye support
- Stainless steel

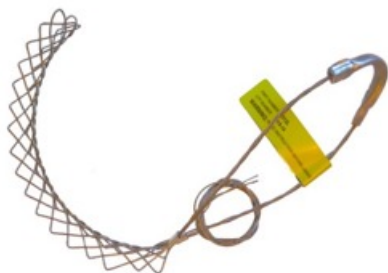

Article #	Description	Quantité
HG-14L	Panier de Levage non-lacé (ouvert) pour câble coaxial 1/4"	1
HG-38L	Panier de Levage non-lacé (ouvert) pour câble coaxial 3/8"	1
HG-12L	Panier de Levage non-lacé (ouvert) pour câble coaxial 1/2"	1
HG-58L	Panier de Levage non-lacé (ouvert) pour câble coaxial 5/8"	1
HG-78L	Panier de Levage non-lacé (ouvert) pour câble coaxial 7/8"	1
Autres codes : 19256B		
HG-114L	Panier de Levage non-lacé (ouvert) pour câble coaxial 1-1/4"	1
HG-158L	Panier de Levage non-lacé (ouvert) pour câble coaxial 1-5/8"	1

Pre-Laced hoisting grip

Pre-laced hoisting grips is a closed-mesh design. The design allows the pre-laced hoisting grip to slip over an unterminated end of coax. The grip securely tightens when pulled, providing an effective means to hoist coax into position and to provide additional support for the coax once in place.

- Others sizes available upon request
- Pre-laced to simplify installation
- Closed mesh with single eye support
- Stainless steel



Article #	Description	Quantité
HG-14C	Panier de Levage pré-lacé (fermé) pour câble coaxial 1/4"	1
HG-12C	Panier de Levage pré-lacé (fermé) pour câble coaxial 1/2"	1
HG-58C	Panier de Levage pré-lacé (fermé) pour câble coaxial 5/8"	1
HG-78C	Panier de Levage pré-lacé (fermé) pour câble coaxial 7/8"	1
HG-114C	Panier de Levage pré-lacé (fermé) pour câble coaxial 1-1/4"	1
HG-158C	Panier de Levage pré-lacé (fermé) pour câble coaxial 1-5/8"	1

Lightning Rods - Air Terminal

Available in tubular copper or full copper.

- UNC 5/8-11 male thread
- Available in safety tipped or taper point
- Others lengths available upon request



Article #	Description	Quantité
TP18SR	Tige Parafoudre, cuivre plein, 18" x 5/8OD, filetage externe 5/8-11, pointe arrondie sécuritaire	1
TP18S	Tige Parafoudre, cuivre plein, 18" x 5/8OD, filetage externe 5/8-11	1
TP48SR	Tige Parafoudre, cuivre plein, 48" x 5/8OD, filetage externe 5/8-11, pointe arrondie sécuritaire	1
TP48S	Tige Parafoudre, cuivre plein, 48" x 5/8OD, filetage externe 5/8-11	1
TP30	Tige Parafoudre, tube appointi, 30" x 5/8OD, raccord filetage externe 5/8-11	1
TP72S	Tige Parafoudre, cuivre plein, 72" x 5/8"OD	1
TP18	Tige Parafoudre, tube appointi, 18" x 5/8OD, raccord filetage externe 5/8-11	1

Support de Tige Parafoudre

Support de paratonnerre, utilisé pour maintenir les paratonnerres en place et les attacher au reste du système. Conception unique pour site télécom, cette base fournit une installation facile et un excellent soutien aux tuyaux ronds.



Article #	Description	Quantité
BTPA	Base de tige parafoudre, fileté 5/8-11.	1

Cable holder

Adhesive cable holder of stamped and formed copper. Should be placed on flat or gently sloping roof surface with approved adhesive. Use when nailing is impractical.

Note: It is important to select an adhesive that is compatible with the roofing system in use. Consult roof manufacturer for correct adhesive to use.



Article #	Description	Quantité
BCH3	Plaque d'attache ment pour fil de mise à la terre pour toiture, ronde 3"	1
BCH2	Plaque d'attache ment pour fil de mise à la terre pour toiture, 2-1/2" x 3"	1

Passe-fils

Rubber grommet 2-3/8 with star center. Use for 1/16 to 1/8 wall thick, cabinet or cable tray.

- Weather and UV resistant EPDM rubber



Article #	Description	Quantité
RGS-238	Insertion de caoutchouc avec centre en étoile pour trous de 2-3/8"	1

Protecteurs

Metal sheet edge rubber protection Protect cables from the edges of cabinet and cable tray.

- Used for 1-3mm thickness metal sheet
- Standard Double Lip Trip 1/32-1/8



Article #	Description	Quantité
EDGP	Protection de caoutchouc pour rebord de feuille d'acier, rouleau de 100m Autres codes : GROMMET, GROMET	100m

Butterfly Hangers

Butterfly hanger provides a versatile means of attaching for different types of individual cables to a variety of support members.

- All Stainless steel
- Compatible with a variety of different cables types
- 3/8" hole for hardware mounting



Article #	Description	Quantité
HA-BTY-12	Attache à câble papillon pour coaxial 3/8" & 1/2" Autres codes : BH12, BH-12, 43211, 43211A	10
HA-BTY-58	Attache à câble papillon pour coaxial 5/8"	10
HA-BTY-78	Attache à câble papillon pour coaxial 7/8" Autres codes : 42396A-5, BH78, BH-78	10
HA-BTY-114	Attache à câble papillon pour coaxial 1-1/4" Autres codes : BH114, BH-114, 42396A-1, BRIDES, 423964-1	10
HA-BTY-158	Attache à câble papillon pour coaxial 1-5/8" Autres codes : 423964-2, BH158, BH-158, BRIDES	10
SSH-12		
	 Attache à câble empilable "snap-in" pour coaxial 1/2"	10
SSH-78	Attache à câble empilable "snap-in" pour coaxial 7/8"	10
SSH-114	Attache à câble empilable "snap-in" pour coaxial 1-1/4"	10
SSH-158	Attache à câble empilable "snap-in" pour coaxial 1-5/8"	10

Cable Blocks

Interior rib construction offer better cable retention. Stackable design allow up to 6 runs of cables supported in one compact bundle.

- UV resistant polypropylene
- Exterior alignment ridge
- 3/8" hole for hardware mounting
- Others sizes available upon request



Article #	Description	Quantité
CB-D10-12	Bloc support pour 2 câbles coaxial 1/2" Autres codes : L4CLICK, CB12, CB-12, 65-ACBD12	10
CB-D10-78	Bloc support pour 2 câbles coaxial 7/8" Autres codes : L5CLICK, CB78, 65-ACBD78, CB-78	10
CB-D10-114	Bloc support pour 2 câbles coaxial 1-1/4" Autres codes : L6CLICK, CB-114, 65-ACBD114, CB114	10
CB-D10-158	Bloc support pour 2 câbles coaxial 1-5/8" Autres codes : L7CLICK, CB158, CB-158, 65-ACBD158	10
CBH375	Cable Block Hardware kits 3/8" SS threaded rod 3.750" for one coax block hanger. Click-on Hanger Hardware Kit Autres codes : CH35, SS38-4, 243095-9, CBHK-3.75	10
CBH537	Cable Block Hardware kits 3/8" SS threaded rod 5.375" for two coax blocks hangers. Click-on Hanger Hardware Kit Autres codes : CH50, SS38-6, 243095-5	10
CBH700	Cable Block Hardware kits 3/8" SS threaded rod 7" for three coax blocks hangers. Click-on Hanger Hardware Kit Autres codes : CH65, SS38-8, 243095-1, CBHK-7	10

Cushion Hangers (Aussi dans Entrée de lignes)

Kit of 5 cushion inserts «any models» with clamp heads and round member adapters (hose clamps).

- Weather and UV resistant EPDM rubber
- Custom sizes available upon request



Article #	Description	Quantité
CH-78-4KIT	Ensemble de 5 supports à câbles en caoutchouc 4 trous pour câbles coaxial 7/8"	5
CH-12-6KIT	Ensemble de 5 supports à câbles en caoutchouc 6 trous pour câbles coaxial 1/2"	5
CH-12-9KIT	Ensemble de 5 supports à câbles en caoutchouc 9 trous pour câbles coaxial 1/2"	5

Hanger Inserts

Rubber grommets use with coax block, snap-in or butterfly hanger and also can be use with entry boots

- Weather and UV resistant EPDM rubber
- Compatible with standard coaxial cable support products
- Others sizes available upon request

Article #	Description	Quantité
RG12-38	Insertion de caoutchouc réducteur de câble coaxial 1/2 vers câble de 1/4" à 3/8" de diamètre extérieur	10







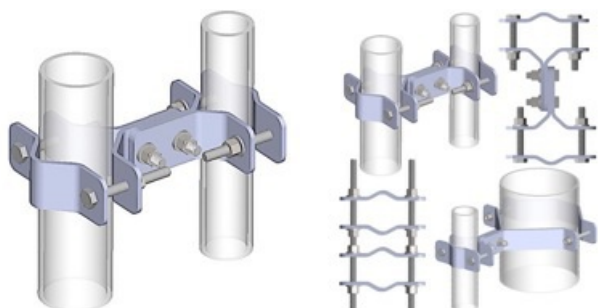

Support à Tuyau sur Tuyau

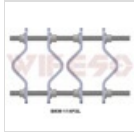
Nos supports sont fabriqués en acier de haute qualité galvanisé à chaud. Nous proposons également des versions en acier inoxydable et des modèles personnalisés sur demande.

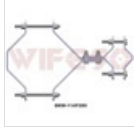

Article #	Description	Quantité
BKW-89P1	Support ancrage de positionnement pour monteuseur 1.5"@3.5"OD Boulon en U n'est pas inclus (Utilisé sur radio pipe Éricson/VL)	1
BKW-89P2L	Support Parallèle tuyau à tuyau Tuyau 1.5" à 3.5" sur tuyau 1.5" à 3.5"	1
BKW-89P2	Support Parallèle tuyau à tuyau Tuyau 1.5" à 3.5" sur tuyau 1.5" à 3.5" Autres codes : CLAMP015, 112-85	1
BKW-89P114	Support Parallèle tuyau à tuyau Tuyau 1.5" à 3.5" sur tuyau 2.75" à 4.75"	1
BKW-89P152	Support Parallèle tuyau à tuyau Tuyau 1.5" à 3.5" sur tuyau 4" à 6.5"	1
BKW-89P228	Support Parallèle tuyau à tuyau Tuyau 1.5" à 3.5" sur tuyau 7" à 9"	1
BKW-89P280	Support Parallèle tuyau à tuyau Tuyau 1.5" à 3.5" sur tuyau 7" à 11"	1
BKW-114P2	Support parallèle tuyau à tuyau Tuyau 2.75" à 4.75" sur tuyau 2.75" à 4.75"	1

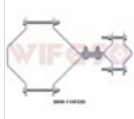
Article #	Description	Quantité
BKW-114P2L	Support parallèle tuyau à tuyau Tuyau 2.75" à 4.75" sur tuyau 2.75" à 4.75"	1
		
BKW-114P152C	Support Parallèle tuyau à tuyau Tuyaux centrés Tuyau 2.75" à 4.75" sur tuyau 4" à 6.5"	1
		
BKW-114P280	Support parallèle tuyau à tuyau Tuyau 2.75" à 4.75" sur tuyau 7" à 11"	1
		
BKW-114P152HD	Support Parallèle tuyau à tuyau Tuyau 2.75" à 4.75" sur tuyau 4"@6.5"	1
		
BKW-89P114C	Support Parallèle tuyau à tuyau Tuyau 1.5" à 3.5" sur tuyau 2.75" à 4.75" Tuyaux centrés	1
		
BKW-114P152	Support Parallèle tuyau à tuyau Tuyau 2.75" à 4.75" sur tuyau 4" à 6.5"	1
		
BKW-114P228	Support Parallèle tuyau à tuyau Tuyau 2.75" à 4.75" sur tuyau 7"@9"	1
		

Support à Tuyaux à 90deg.

Nos supports sont fabriqués en acier de haute qualité galvanisé à chaud. Nous proposons également des versions en acier inoxydable et des modèles personnalisés sur demande.

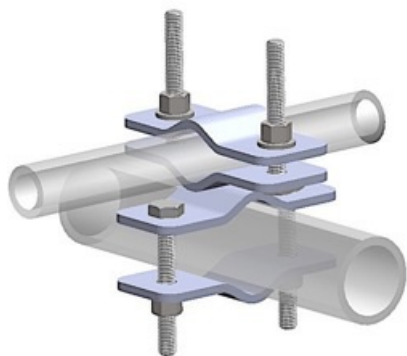

Article #	Description	Quantité
-----------	-------------	----------

BKW-89T2



Support tuyau à tuyau à 90°
Tuyau 1.5" à 3.5" sur tuyau 1.5" à 3.5"

1

BKW-89T114

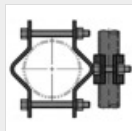

Support tuyau à tuyau à 90°
Tuyau 1.5" à 3.5" sur tuyau 2.75" à 4.75"

1

BKW-89T152

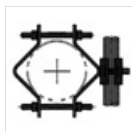

Support tuyau à tuyau à 90°
Tuyau 1.5" à 3.5" sur tuyau 4" à 6.5"

1

Support à Tuyau sur Fer-Angle

Nos supports sont fabriqués en acier de haute qualité galvanisé à chaud. Nous proposons également des versions en acier inoxydable et des modèles personnalisés sur demande.

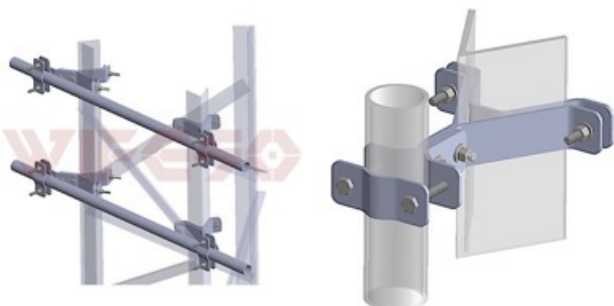

Article #	Description	Quantité
-----------	-------------	----------

BKW-89A1026



Support parallèle de tuyau sur fer-angle de 60°
Tuyau 1.5" à 3.5" sur fer-angle 2" à 4"

1

BKW-89A1029



Support parallèle de tuyau sur fer-angle de 90°
Tuyau 1.5" à 3.5" sur fer-angle 2" à 4"

1

Autres codes : **CLAMP015C**

BKW-89A1146



Support parallèle de tuyau sur fer-angle de 60°
Tuyau 1.5" à 3.5" sur fer-angle 3" à 4.5"







1



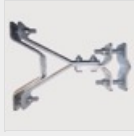



BKW-89A1526



Support parallèle de tuyau sur fer-angle de 60°
Tuyau 1.5" à 3.5" sur fer-angle 5" à 6"

1

Article #	Description	Quantité
BKW-89A1769	 <p>Support parallèle de tuyau sur fer-angle de 90° Tuyau 1.5" à 3.5" sur fer-angle 4.5" à 7"</p>	1
BKW-89A2036	 <p>Support parallèle de tuyau sur fer-angle de 60° Tuyau 1.5" à 3.5" sur fer-angle 7" à 8"</p>	1
BKW-89AH1026	 <p>Tuyau horizontal sur fer-angle de 60° Tuyau de 1.5" à 3.5" sur fer-angle de 2" à 4"</p>	1
BKW-89AH1029	 <p>Tuyau horizontal sur fer-angle de 90° Tuyau de 1.5" à 3.5" sur fer-angle de 2" à 4"</p>	1
BKW-89AH1146	 <p>Tuyau horizontal sur fer-angle de 60° Tuyau de 1.5" à 3.5" sur fer-angle de 3.5" à 4.5"</p>	1
BKW-89AH1526	 <p>Tuyau horizontal sur fer-angle de 60° Tuyau de 1.5" à 3.5" sur fer-angle de 5" à 6"</p>	1
BKW-89AH1769	 <p>Tuyau horizontal sur fer-angle de 90° Tuyau de 1.5" à 3.5" sur fer-angle de 4.5" à 7"</p>	1
BKW-89AH2036	 <p>Tuyau horizontal sur fer-angle de 60° Tuyau de 1.5" à 3.5" sur fer-angle de 7" à 8"</p>	1

Article #	Description	Quantité
BKW-114A1029	Support Parallèle tuyau sur fer-angle 90° Tuyau 2.75" à 4.75" sur fer-angle 2" à 4"	1
		
BKW-114A1146	Support parallèle de tuyau sur fer-angle de 60° Tuyau 2.75" à 4.75" sur fer-angle 3" à 4.5"	1
		
BKW-114A1526	Support parallèle de tuyau sur fer-angle de 60° Tuyau 2.75" à 4.75" sur fer-angle 5" à 6"	1
		
BKW-114A1769	Support parallèle de tuyau sur fer-angle de 90° Tuyau 2.75" à 4.75" sur fer-angle 4.5" à 7"	1
		
BKW-114A2036	Support parallèle de tuyau sur fer-angle de 60° Tuyau 2.75" à 4.75" sur fer-angle 7" à 8"	1
		
BKW-152A1526	Support parallèle de tuyau sur fer-angle de 60° Tuyau 4" à 6.5" sur fer-angle 5" à 6"	1
		
BKW-152A2036	Support parallèle de tuyau sur fer-angle de 60° Tuyau 4" à 6.5" sur fer-angle 7" à 8"	1
		

Support à Tuyau sur Mur ou Poteau de Bois

Nos supports sont fabriqués en acier de haute qualité galvanisé à chaud. Nous proposons également des versions en acier inoxydable et des modèles personnalisés sur demande.

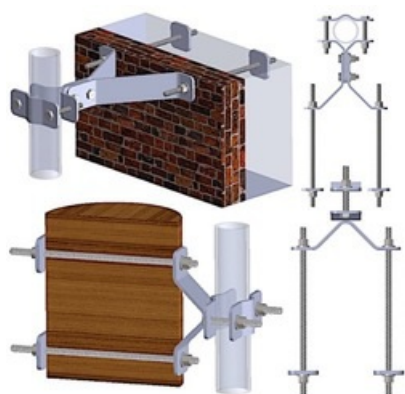

Article #	Description	Quantité
BKW-89TP90	Tuyau sur poteau de bois à 90° Pour tuyau 1.5"@3.5"OD Autres codes : CLAMP017A, CLAMP017A	1
BKW-89TP115	Tuyau sur poteau de bois à 90° Pour tuyau 1.5"@3.5"OD Autres codes : 115P-85	1
	Support à tuyau sur poteau de bois à 90°	
BKW-114TP	Tuyau 2.75" à 4.75" (Boulons pour poteau ne sont pas inclus)	1
	Support à tuyau sur poteau de bois à 90°	
BKW-152TP	Tuyau 4" à 6.5" (Boulons pour poteau ne sont pas inclus)	1
BKW-89W144	Support à tuyau sur mur Tuyau 1.5" à 3.5"	1
BKW-89W177	Support à tuyau sur mur Tuyau 1.5" à 3.5"	1
BKW-89W292	Support à tuyau sur mur Tuyau 1.5" à 3.5"	1
BKW-114W177	Support à tuyau sur mur Tuyau 2.75" à 4.75"	1
BKW-114W127	Support à tuyau sur mur Tuyau 2.75" à 4.75"	1